

Control of metabolic activities of *E.coli* and *S. aureus* bacteria by Electric Field at Resonance Frequency in vitro study

Sahar E.Abo-Neima^{1*}, Yasser I.Khedr¹, Metwaly M.Kotb², Ahmed Elhoseiny³
and Hussein A.Motaweh¹

¹ Department of physics, Faculty of Science, Damanhur University, Egypt

² Department of Medical Biophysics, Medical Research Institute, Alexandria University, Egypt

³ Master Student at Department of physics, Faculty of Science, Damanhur University, Egypt.

*corresponding author E-mail:Sahar_amr2002@yahoo.com

Abstract: Low electric currents generated using conductive electrodes have been used to increase the efficacy of antibiotics against bacterial biofilms, a phenomenon termed "the bioelectric effect" that formed metal ions and free radicals which can inhibit the growth of planktonic *Staphylococcus aureus* (*S.aureus*) and *Escherichia Coli* (*E.Coli*) the effect is amplitude and frequency dependent, the aim of present study to define the parameters that are most effective against bacterial growth also to investigate the comparative study through inactivation of metabolic activities, growth rate, morphology, bacterial conductivity and antibiotic sensitivity between gram negative *E.Coli* and gram positive *S.aureus* bacteria by extremely low frequency electric field (ELF-EF). In this work, the frequency of electric impulses that interfere with the bioelectric signals generated during *E.Coli* and *S.aureus* cellular division is investigated in order to compare cell viability, number of colony forming units (CFU) and growth rate (optical density at 600nm) bacterial conductivity and antibiotic susceptibility. Also morphological cellular structure was investigated by transmission electron microscope (TEM). The results revealed that a highly significant inhibition effect occurred when *S.aureus* and *E.Coli* was exposed to resonance of 0.8, 0.5 Hz square amplitude modulated waves (QAMW) respectively for 2hours exposure .Moreover, exposed cells became more sensitive to the tested antibiotics compared to control. Significant ultra-structural changes occurred as observed by TEM which indicated morphological changes. It will be concluded that, the use of 0.8, 0.5 Hz QAMW in controlling the biological activity of *S.aureus* and *E.coli* respectively seems to be a new and promising medical activity.

Key words: *S.aureus* , *E.Coli* , electric field, modulated waves, TEM, antibiotic susceptibility.

I. Introduction

In the modern society, greater use of technologies leads to increasing exposure to extremely low-frequency electromagnetic fields ((ELF-EMFs) generated by structures and appliances such as power lines and ordinary devices used inside house and work places. As consequence, the effects of ELF-EMFs on the biological functions of living organisms represent an emerging area of interest with respect to environmental influences on human health. In latest years, several studies have been performed to verify direct effects exerted by ELF-EMF on cell functions. Although results have been somewhat controversial, a variety of cell responses have been observed involving proliferation and differentiation [1,2], gene expression [3,4], modulation of the membrane receptors functionality [5,6], apoptosis [7,8], alteration in ion homeostasis [1,9,10,11,12], and free radicals generation [13,14,15].

Bacteria have also been used in the studies with ELF-EMF [16,17]. In particular, it has been demonstrated that ELF-EMF can negatively [18, 19, 20, 21, 22] or positively [21, 23, 24, 25, 26] affect functional parameters cell growth , viability and bacteria antibiotic sensitivity depending on physical parameters of the EMFs (frequency and magnetic flux density) applied, the time of the exposure, and/or the type of bacteria cells used.

The use of physical means as an aid for modern medicine in the continuous battle against pathogenic microorganisms holds new prospects that only recently have begun to be widely recognized. Light sources of various types are being used for photodynamic therapy in dentistry and dermatology [27, 28, 29].Ultrasound waves are used for human dental plaque removal [30] and, in combination with antibiotics, for the eradication of bacterial biofilms in vitro and in vivo [31, 32, 33, 34].

Antimicrobial resistance is a public health threat, which is being caused by inappropriate use of anti-infective drugs in human and animal health as well as food production, together with inadequate measures to control the spread of infections [35]. Because the use of an antibiotic inevitably selects for resistant microbes, there is a continuing need for new drugs to combat the current generation of resistant pathogens [36]. Frequent misuse of antibiotics leads to bacterial evolution to Multidrug-Resistant Strains (MDR), spreading in human

populations. Therefore, considerable efforts have been made towards the development of alternative method for the treatment of bacterial infections.

Over the last few years, bacteria were subjected to many experimental procedures to evaluate how such unicellular systems may be controlled by EMFs [37,38,39,40,41] However, the medical application of the majority of this work is quite limited due to the need of very high field strengths of several KV/cm and very high temperatures. Recently, the efforts were devoted to control cellular activities using electromagnetic waves of very low field intensity and frequencies which resonates with bioelectric signals generated during a particular metabolic activity. These trials succeeded to control the growth of Ehrlich tumors in mice [42, 43] and fungi [44] .In this study, a trial was made to find out the resonance frequency of the electromagnetic waves that can inhibit the activity of bacteria and its ability to make division, as well as to investigate the changes that may occur at the molecular level as a result of exposure to ELF-EMFs.

The use of an additional physical means, weak electric currents, to inhibit bacterial growth was suggested by Rosenberg et al. [45], who observed that electrolysis resulted in the arrest of *Escherichia coli* cell division. Further investigation of this phenomenon revealed that transition platinum complexes produced at the platinum electrodes during electrolysis were responsible for the bacterial growth inhibition.

In the years to follow, it was demonstrated that low-intensity electric currents, mostly direct current (DC) [46,47,48,50,51],as well as alternating electric fields of as much as 10 MHz [52,53], can enhance the efficacy of antibacterial agents against bacterial biofilms. In all of these studies, the electric currents were generated using conductive electrodes, allowing for the formation of metal ions and free radicals at the electrode surface these products are toxic to human cells, and therefore the use of such electric currents was limited. We have therefore attempted to investigate the possible influence of ELF-EMF on growth and antibiotic sensitivity of reference strains. To this end, we exposed *E. coli* and *S.aureus* to SAMW at resonance frequency. These representative strains were chosen as examples of well-characterized Gram-negative bacteria, widely distributed in the environment and clinically relevant in nosocomial infections. Therefore, we evaluated the in vitro effect of electric fields on the metabolic activities of these.

II. Materials and methods

Test strains and growth conditions

The *S.aureus* (ATCC# 25923) and *E.Coli* (ATCC# 25922) cells used in the present study were supplied by Ocology center in Damanhour, Egypt. Muller-Hinton broth (Becton Dickinson, U.S.A) and Muller-Hinton agar (Becton Dickinson, U.S.A) were used as a culture media. Muller-Hinton broth contains beef extract powder, and acid digest of casein, and soluble starch. Muller-Hinton agar contains agar in addition to the above reagents mentioned in Muller-Hinton broth composition [54, 55]. All other reagents used were of the purest grade commercially available. All strains were grown in Liquid Broth (LB) medium (1.0% Bacto tryptone, 0.5 % yeast extract, 1.0% NaCl). Broth cultures of freshly plated bacterial strains were grown in 3ml of liquid medium at 37°C for 16 h in an orbital shaker (220 rpm; New Brunswick Scientific, NJ) and diluted in fresh LB broth to a predetermined absorbance at 600nm (Biowave cell density meter; WPA, United Kingdom), which yielded the desired CfU/ml.

Exposure Facility System

Fig.1. indicates sketch diagram for synthesized function generator of the exposure facility of the bacterial culture, Samples of *E.Coli* and *S.aureus* were exposed to different modulating frequencies of Square Amplitude Modulated Waves (SAMW). The modulating waveform was square. The carrier and modulating carried wave were generated by synthesized arbitrary function generator type DS345 manufactured by Stanford Research System. The amplitude of the wave carrier was 10Vpp and the modulating depth was $\pm 2V$. Electric field strength at the samples was about 200 V/m. The samples in autoclaving tube were exposed to the AMW through two parallel copper disk electrodes, each of diameter 8 cm and the distance between two electrodes 1.5 cm. During our trials to find out the resonance frequency of the modulating waves, samples were exposed for 60 min (The test exposure time) to each frequency. After finding the resonance frequency a trial was made to evaluate the most effective exposure time.

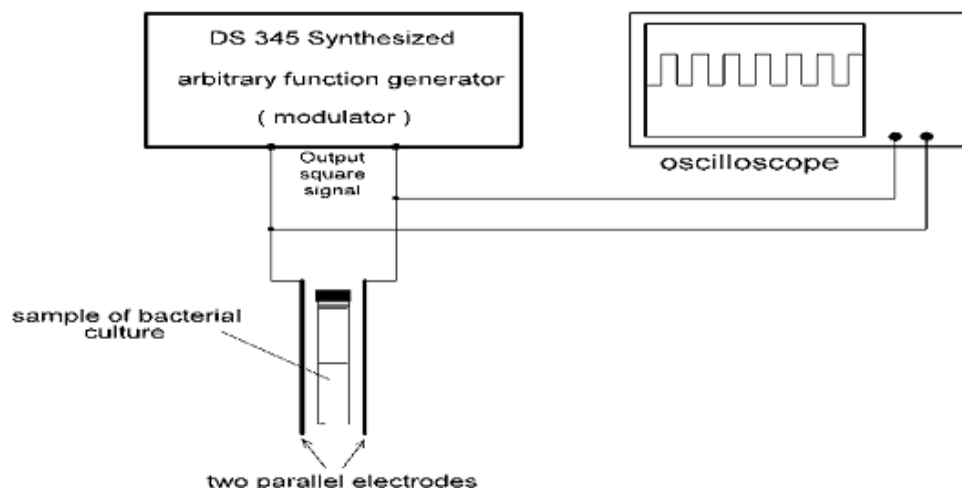

Fig.1. sketch diagram for electric exposure facility system.

Growth curves of bacterial cells

Bacterial growth was determined via two by two methods the first for measuring absorbance and the second by counting colonies developed on agar plates (standard plate count). To study the bacterial growth, standard calibration curve was plotted between the absorbance of the samples at 600 nm (using clean broth medium as reference sample) [56] and the concentrations of the cells (Cfu/mL) as determined by plate counting technique [57]. The optical density was chosen at 600nm (OD₆₀₀) because this wave length is preferable to UV spectroscopy when measuring the growth over time of a cell population because at this wave length, the cells will not be killed as they would under too much UV light, the absorbance of the samples was measured through the use of a spectrophotometer model (UV/visible spectrophotometer LKB-Nova spec, made in England). In this technique, appropriate dilutions of the bacterial cells were used to inoculate nutrient agar plates. Inoculated plates then incubated at 37°C for 24hr. By counting the number of colonies developed after incubation and multiplying it with the dilution factor the number of cells in the initial population was determined with Cfu /ml, Pipette 0.1mL from the sequence of dilutions onto plate count Agar using the spread plate method. When the surface of the plate count agar becomes dry, invert the plates and incubate at 37°C for 24hours then count all plates which contained 20 to 300 colonies and calculate the total plate count per ml.

Application of electric field to bacteria

Overnight bacterial cultures were diluted in fresh LB broth to an optical density (OD) corresponding to bacterial counts of 1×10^7 Cfu/ml. A broth subculture was prepared by inoculating a test tube containing 5ml of sterile nutrient broth of pH 7.1 with two single colonies of bacteria from nutrient agar Plate, followed by incubation at 37°C for 24 h. Standard inoculums was used to inoculate 500 ml screw-capped flasks containing 150 ml of sterile nutrient broth to reach a final concentration of 10^6 Cfu/ml. The cultures were then incubated at 37°C, but the incubation was interrupted each one hour, as sample was taken for absorbance measurement (using sterile broth medium as reference) at wavelength 600 nm using a spectrophotometer model (UV/visible spectrophotometer LKB-Nova spec, made in England), and the concentration of cells (number of cells Cfu/ml) was determined by plate counting technique [57] and appropriate dilutions of the bacterial cells were used to inoculate nutrient agar plates.

Inoculated plates were then incubated at 37°C for 24 h by counting the number of colonies developed after incubation and multiplying it with the dilution factor the number of cells in the initial population is determined with Cfu/ml. Each experiment was repeated three times and the average was considered. The culture was left to grow of *E.Coli* & *S.aureus* then a part of the sample was taken to mix with clean broth medium. After mixing process (time t=0 h) the new culture was divided into eleven groups, one control, the others were exposed to SAMW for different frequencies in the range 0.1 to 1 Hz in steps of 0.1Hz for 60 min (the test exposure time) in order to determine the resonance frequency of growth inhibition. The morphological changes of control group and group exposed to 0.8 Hz square electric pulse (resonance frequency will be discussed latter in more details) have been determined using transmission Electron Microscope (TEM). The bacterial samples were prepared for imaging by the TEM through some processing [58]. TEM investigation was done in TEM unit, Faculty of Science, Alexandria University.

Growth curve of bacterial cells treated with electric field

To study the growth curves of bacterial cells exposed to electric field at resonance frequency, Muller–Hinton broth was used, and the bacterial cell concentration was adjusted to 106 CfU/ml [59]. Each culture was incubated in a shaking incubator at 37°C for 24 h. Growth curves of bacterial cell cultures were attained through repeated measures of the optical density (O.D) at 600nm using a spectrophotometer model (UV/visible spectrophotometer LKB-Nova spec, made in England), and the concentration of cells (number of cells CfU/ml) was determined by plate counting technique and appropriate dilutions of the bacterial cells were used to inoculate nutrient agar plates. Inoculated plates were then incubated at 37°C for 24h by counting the number of colonies developed after incubation and multiplying it with the dilution factor the number of cells in the initial population is determined with CFU/ml [60].

Transmission electron microscopy (TEM)

A log phase culture of *S.aureus* & *E.Coli* in Mueller–Hinton broth was split into 1.5 mL aliquots. The cells were collected by centrifugation (10000 rpm, 5 min) and suspended in peptone water. Six samples were prepared; two untreated, two treated with SMAP29 (41g/mL) and two treated with OaBac5mini (64 1g/mL). The samples were incubated at 37°C for 1h. The cells were collected by centrifugation (10000 rpm, 5 min) to remove the peptone water. To fix the cells, 2% glutaraldehyde in 0.1 M cacodylate was added and the samples were incubated at 4°C for 1 h. The cells were collected by centrifugation (10000 rpm, 5 min) and washed twice with 0.1 M phosphate buffer. To postfix the cells, 1% osmium tetra oxide was added and the samples were left at room temperature for 1 h. The samples were dehydrated with graded ethanol solutions (30% ethanol for 10 min, 60% ethanol for 10 min, 90% ethanol for 10 min, 100% ethanol for 10 min, 100% ethanol for 1h), embedded in Procure 812 resin and left to polymerise (over the weekend). From each sample 10 thin slices (approximately 100 nm) were cut with a diamond knife and stained with uranyl acetate and lead citrate on grids. Each of these sections was examined with a Philips EM201 80 kV Transmission Electron Microscope and images were taken with a 35-mm camera [61, 62].

Antibiotic susceptibility test (AST)

S.aureus and *E.Coli* bacterial cells were tested for their in vitro susceptibility to various antibiotics using the agar diffusion method. The antibiotics used in this study were chosen to represent different modes of action. These discs were Amicacin [AK(30µg)], Ampicillin [AMP (10µg)], Ceftriaxone [CRO (30µg)], Cefuroxime [CXM (30µg)], Cefotaxime [CAZ (30µg)], Amoxicillin/Clavulanic acid [AMC (30µg)], Ampicillin-Sulbactam [SAM(30µg)] and Cefazolin [KZ (30µg)] which inhibit cell wall synthesis. Also, Ciprofloxacin [CIP (5µg)], Ofloxacin [OFX (5µg)], and Norfloxacin [NOR (10µg)] which are inhibitors for bacterial DNA, in addition to [E (15µg)], and Chloramphenicol [C (30µg)] which are inhibitors for proteins. After plate inoculation and incubation at 37°C for 24 h, the diameters of the inhibition or stimulation zone of exposed and unexposed cells were measured in mm.

Statistical analysis

All experiments were repeated at least three times and the statistical significance of each difference observed among the mean values was determined by standard error analysis. The results were represented as means ± SD. Data from bacterial growth studies were compared using Student T-test and ANOVA analysis, the level of significance was set at $p < 0.05$, which was considered statistically significant [22, 23].

III. Results

Survival Curve of bacteria

Fig.2a,b. indicated the variation of the number of microorganisms of *S.aureus* and *E.Coli* respectively in CFU / ml as a function of the sample absorbance measured at 600 nm. The results show linear dependence of the absorbance on the number of microorganisms in count /ml.

Fig3a,b. illustrates the growth characteristic curve for control *S.aureus* & *E.Coli* bacteria. From the plot it is clear that the lag phase ended at 5hr followed by the exponential growth period started after 6h and ended at 9hr followed by the stationary phase for two microorganisms

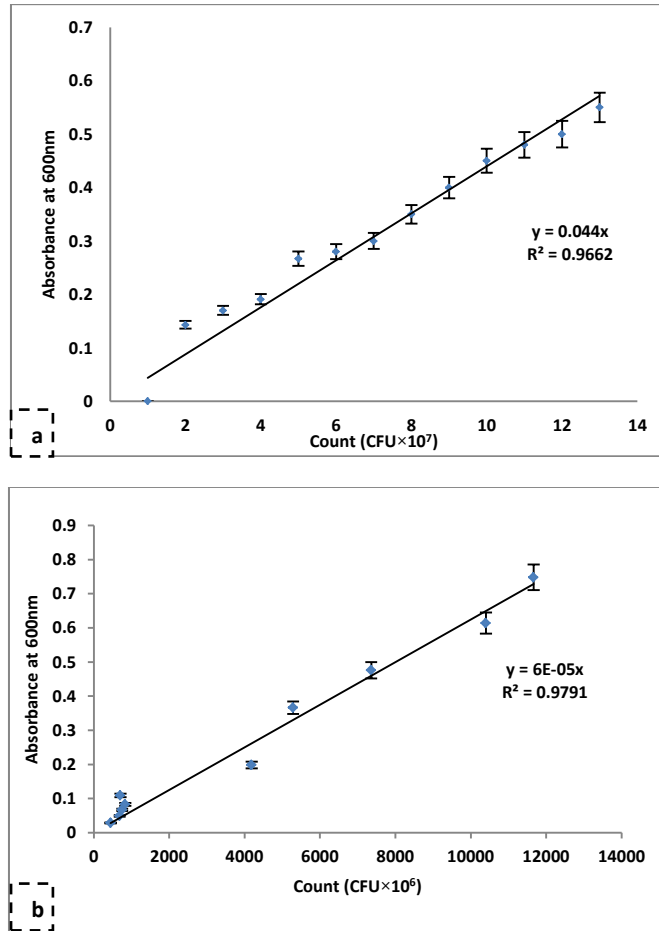
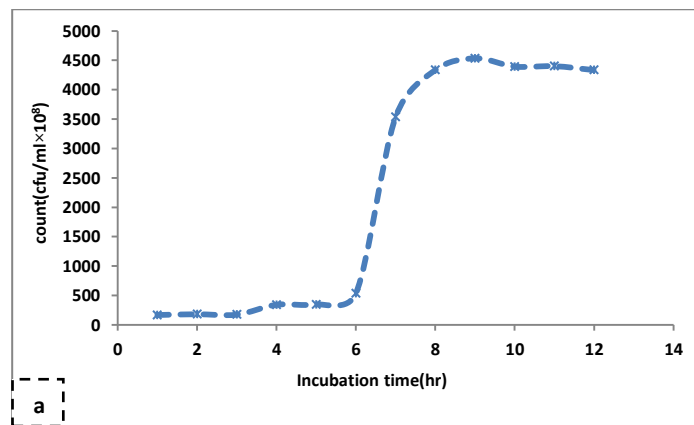

Fig.2a,b. Calibration curve between the number of bacteria (cells/ ml) and Absorbance at 600nm for *S.aureus* (Fig.2a) and *E.Coli* (Fig.2b) respectively .



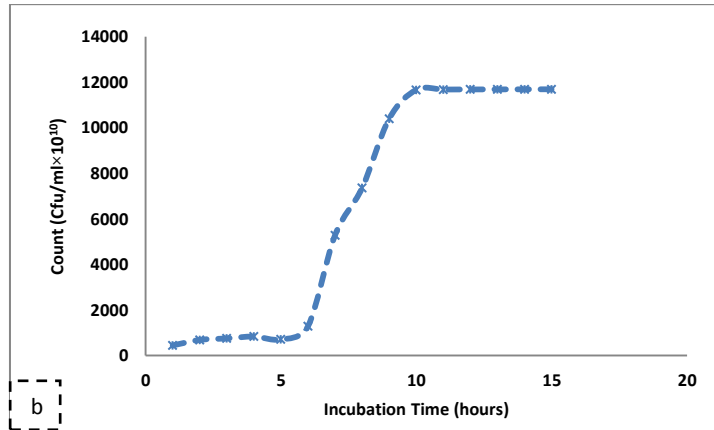

Fig3a,b. Growth characteristics curve for control bacteria *S.aureus* (a) and *E.Coli*(b) .

Growth characteristics curve for control and exposed bacteria

The growth curve for *S.aureus* & *E.Coli* was measured for different samples after the exposed to SAMW for a period of 60 min (the test exposure time) at different amplitude modulating frequencies. This experiment started with a pilot study where the frequency of the applied electric waves was changed to cover the frequency ranges from 1.0 to 50 Hz in steps of 5 Hz. There was no change in the growth curve for the samples exposed to SAMW in the frequency range from 1.0 to 50Hz for two microorganisms. The change of absorbance at 10 hr incubation time with respect to control as a function of SAMW frequency in the range 0 Hz up to 1.0 Hz is shown in Fig.4a,b

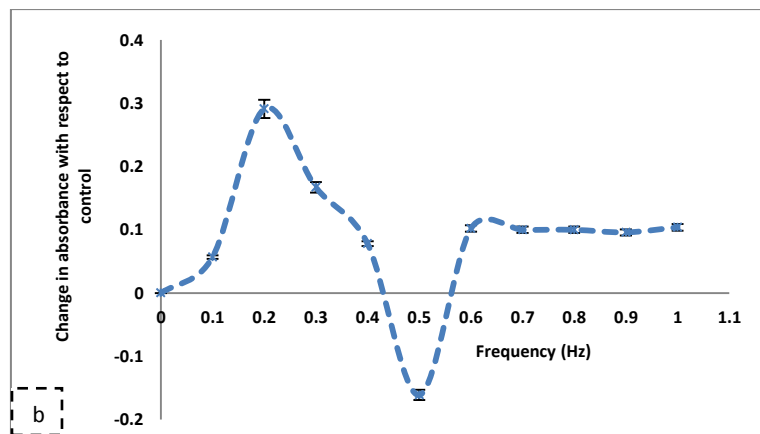
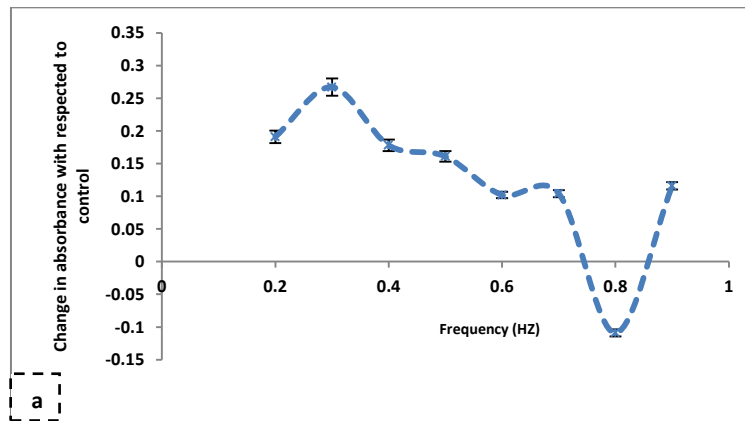

Fig.4a,b. Changes in the absorbance post 10 hr incubation with respect to control as a function of frequency for *S.aureus* (a) & *E.Coli* (b) respectively .

The changes in the growth curve characteristics for samples exposed for 60 min to 0.8 Hz, 0.5Hz SAMW for *S.aureus* and *E.Coli* respectively as compared with control (un exposed). The difference from

control was significant ($p < 0.05$). The concentration of the samples in (Cfu/mL) was calculated and given in Table (1). It is clear from the table that the population intensity of the bacterial sample at the stationary phase has been reduced for sample exposed to resonance frequency for two microorganisms as compared with control. The difference from control was highly significant ($p < 0.001$).

Table.1 Concentration of *S. aureus* and *E.Coli* in (cfu/ml) before and after exposure to 0.8, 0.5Hz SAMW respectively.

Sample	Concentration of microorganisms at stationary phase	
	<i>S.aureus</i>	<i>E.Coli</i>
unexposed	4.4×10^{11}	1.2×10^{14}
Exposed	(inhibition)	inhibition

Effects of exposure time

In this experiment the effect of exposure time on the growth characteristics of the microorganisms was done. The samples were exposed continuously to 0.8, 0.5Hz SAMW for the assigned periods for *S.aureus* and *E.Coli* respectively. Fig.5,6 revealed to viable count of *S.aureus* and *E.Coli* received continuous exposed to resonance frequency for different periods. The results show that as the exposure time increase, the inhibition effect of the bacterial culture increase (the maximum inhibition effect occurred at 120 min exposure) for *S.aureus* and *E.Coli*. The difference from control was very high significant ($P < 0.0001$).

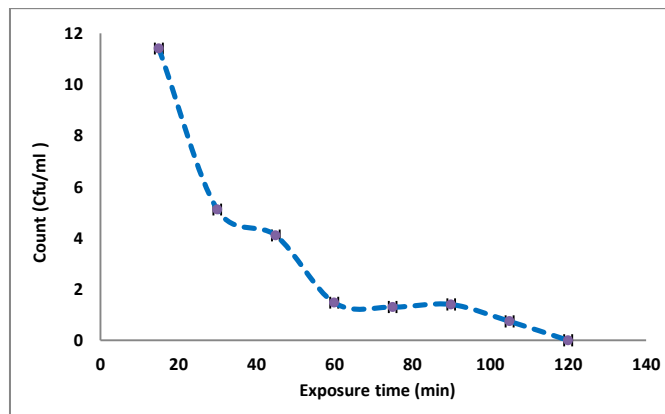

Fig.5. Viable count of *S.aureus* received continuous exposed to 0.8 Hz SAMW for different periods

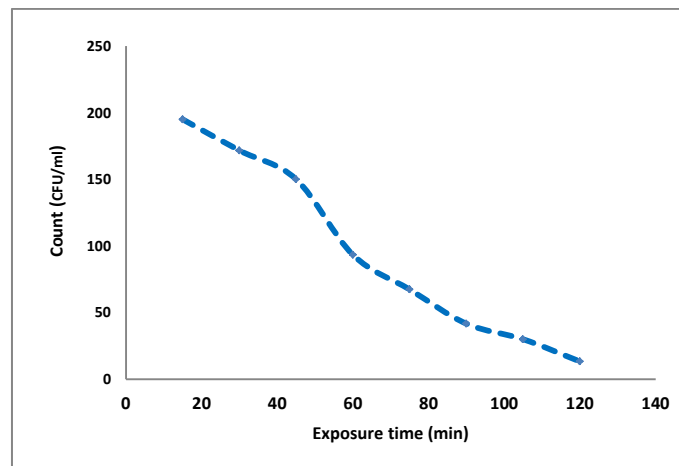

Fig.6. Viable count of *E.Coli* received continuous exposed to 0.5 Hz SAMW for different periods

Effect of electric field on the Sensitivity of Bacteria to the Antibiotic

Fig 7 & Fig 8. Shows Histogram of inhibition zone diameter for *S.aureus* and *E.Coli* bacterial sample for unexposed and exposed to 0.8, 0.5Hz SAMW for 120 min respectively. In Table.2 & Table.3. Indicates the antibiotic sensitivity test results of bacteria which are tabulated for both control and exposed samples to 0.8, 0.5Hz SAMW for 120 min. In this test 15 different antibiotics having different biological actions on the microorganisms.

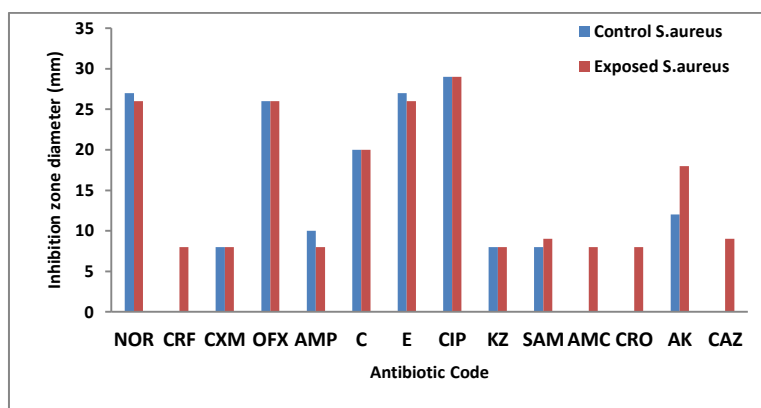

Fig.7. Histogram of inhibition zone diameter for *S.aureus* sample unexposed and exposed to 0.8 Hz SAMW for 120 min respectively.

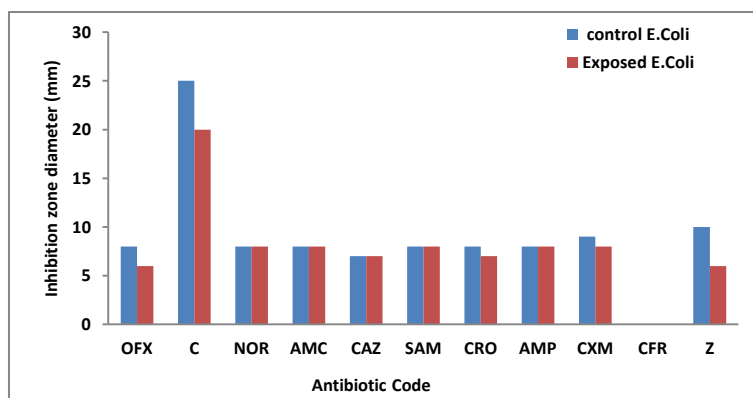

Fig.8. Histogram of inhibition zone diameter for *E.Coli* unexposed and exposed to 0.5 Hz SAMW for 120 min respectively.

Table.2 Antibiotic sensitivity of *S. aureus* before and after exposed (Mean inhibition zone diameter in mm).

Antibiotics	Before treated	treated
<i>Cell wall inhibitors</i>		
AMP	10	8
CRO	No inhibition zone	8
CXM	8	8
AMC	No inhibition zone	8
AK	8	8
SAM	8	9
KZ	8	8
CFR	0	8
<i>Protein inhibitors</i>		
C	20	20
E	27	26
<i>DNA inhibitors</i>		
NOR	27	36
CIP	29	29
OFX	26	26

Table.2 Antibiotic sensitivity of *E.Coli* before and after exposed (Mean inhibition zone diameter in mm).

Antibiotics	Before treated	treated
<i>Cell wall inhibitors</i>		
AMP	10	8
CRO	No inhibition zone	8
CXM	8	8
AMC	No inhibition zone	8
AK	8	8
SAM	8	9
KZ	8	8
CFR	0	8
<i>Protein inhibitors</i>		
C	20	20
E	27	26
<i>DNA inhibitors</i>		
NOR	27	36
CIP	29	29
OFX	26	26

Effect of EF on the ultra-structure of bacterial cells

Fig.9 depicts the TEM images for the ultra-structure it is clearly shown in Fig.9a. for control *S.aureus* this photo agreement with sahar, et al [63]in which the cell membrane smooth, The untreated *S. aureus* cells appears a dark area where the sample had a high electron density. retained their coccal morphology and the appearance of peptidoglycan layer and cytoplasmic membrane, but the morphological investigation after exposure to 0.8Hz SAMW Fig.9.from b to d, it turned significantly rough, the coccoidal shape of treated *S.aureus* with 0.8Hz SAMW was lost and not preserved and deformations/identations of the cell surface can be observed, this is an indicator for cell death is the result of the extensive loss of cell contents, the exit of critical molecules and ions, or the initiation of autolytic processes [64]

From the TEM images, it is particularity that *S.aureus* cells were killed by using 0.8 Hz SAMW. The morphological changes of *E.Coli* bacterial cells were observed by TEM. Fig.10a revealed the TEM of untreated *E.Coli* which shows normal structure of cell membrane but *E.Coli* exposed to 0.5 Hz SAMW electric field (Fig10b,c,d) showed several cells with a roughness of the cell surface can be observed. This increase in roughness and amorphous mass could be associated with the perforation of the cell wall with release of intracellular material and subsequent cell wall deformation and cell wall thickening [65].Disruptions with release of intracellular material associated to *E.Coli* cells losing their cytoplasm (empty and flaccid cells) were also observed. Cell ghost is an empty intact cell envelope structure devoid of cytoplasmic content including genetic material. The distortion of the physical structure of the cell could cause the expansion and destabilization of the membrane and increase membrane fluidity, which in turn increases the passive permeability and manifest itself as a leakage of various vital intracellular constituents, such as ions, ATP, nucleic acids, sugars, enzymes and amino acids. Cell wall perforation with release of significant intracellular components, projections of the cell wall and release of membrane vesicles were observed. Accumulations of membranous structure in the cytoplasm of the biocides treated cells, and there is granularity with regions where DNA fibrils are evident. Also coagulate material were seen inside the treated cells. The light area show where the sample had a low electron density, extrusion of the cytoplasmic content, disruptions with release of intracellular material and losing their cytoplasm changes took place in its membrane morphology that produced a significant increase in its permeability affecting proper transport through the plasma membrane, leaving the bacterial cells incapable of properly regulating transport through the plasma membrane, resulting into cell death. It is observed that electric field have penetrated inside the bacteria and have caused damage by interacting DNA.

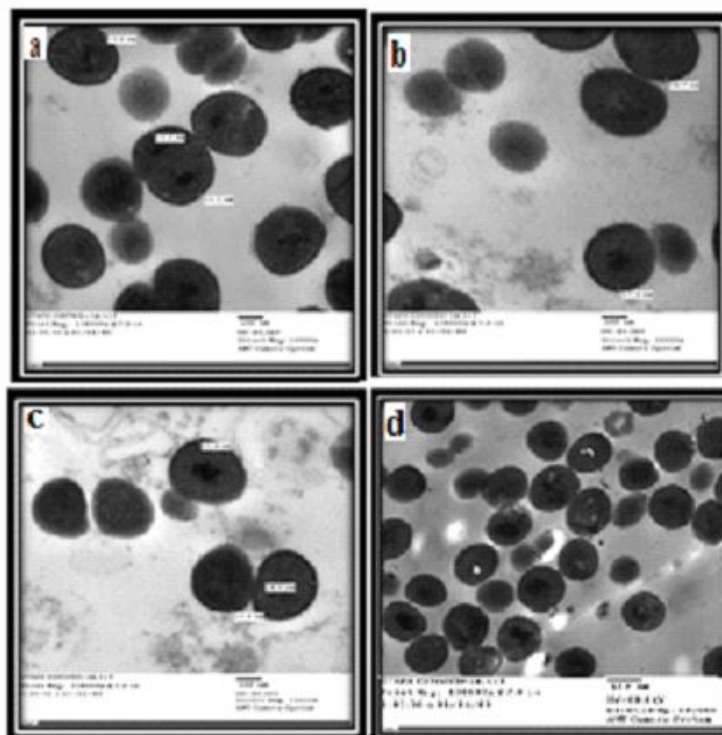

Fig.9. internal structure of *S. aureus* observed by TEM. (a) Untreated bacteria. Images from (b to d) represent treated cells of *S.aureus* exposed to 0.8 Hz SAMW electric field.

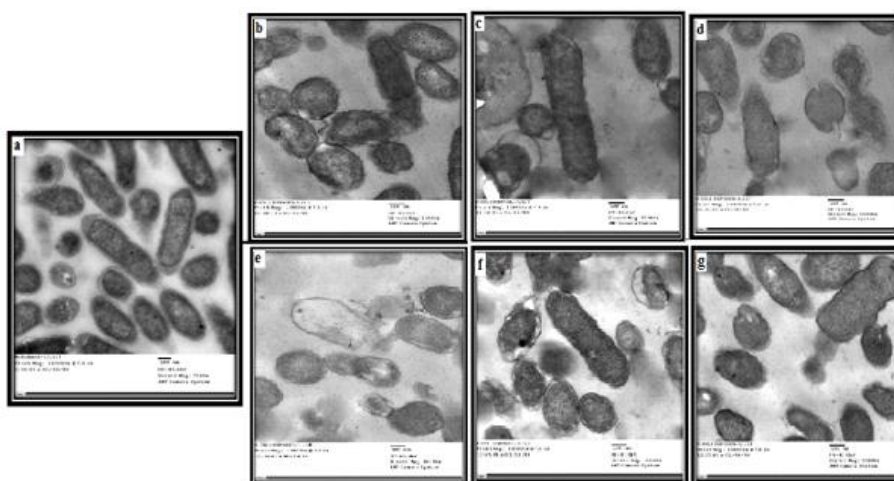

Fig.10. internal structure of *E.Coli* observed by TEM. (a) Untreated bacteria. Images from (b to g) represent treated cells of *E.Coli* exposed to 0.5 Hz SAMW electric field.

IV. Discussion

In this study, a new method for controlling the growth of *S.aureus* and *E.Coli* by using ELF-EMFs was studied. The main objective of this work was to find out the frequency of the ELF-EMFs that resonates with the bioelectric signals generated from microbe during cell division and studying the changes that may occur in its cell membrane structure.

In the present work a new method for controlling the growth of *S.aureus* and *E.Coli* by using electromagnetic therapy was studied, *S.aureus* and *E.Coli* was chosen to be model of study for many reasons, their rapid growth rate, its widely distributed in the environmental and pathogenic microorganism which is a series disease difficult to be treated with conventional drugs because the multiple drug resistance (MDR) problem as well as the side effects of the used antibiotics.

Biological systems, in vivo, generate electric currents and signals associated with magnetic signals, resulting from the running physiological mechanisms. In these mechanisms, ionic current loops are involved which are responsible for all bioelectric signals generated. The form, frequency and amplitude of the resulting bio-electric signals are specific and characterize the running physiological processes. Resonance interference

between two EM Waves can occur when two waves of the same frequency superimpose and the resultant is the algebraic summation of the two waves.

Based on this understanding, an applied EMW can interfere with bioelectric signal when they are in resonance and the resultant is the net summation of the two waves which may cause either enhancement or inhibition of the running physiological process

The present findings indicated that there is a destructive resonance interference of the applied square wave at 0.8 Hz for *S.aureus* and 0.5 Hz for *E.Coli* (Figs 4a,b) with the bioelectric signals generated during the microbial cellular division. The application of these waves may cause the deflection of the ions involved in the mechanism from their normal pass ways for cellular division, and hence caused the deterioration of the process.

The difference between the percentage of inhibition in cellular division of exposed bacterial cells as measured by absorbance and viable plate counting techniques may be due to the fact that counting of microbial cells reflects real number of active micro-organism, while the absorbance technique did not differentiate between dead, inactive or active cells. Exposure of the microorganism to this frequency for two hours gave the maximum inhibiting effect for the microbial cellular division. The exposure to this frequency and for two hours caused both cellular membrane damage (as noticed from the TEM).

Based on the Metabolic Bio-magnetic Resonance Model (BMRM) suggested by Fadel [66], to control physiological functions in biological systems, it is necessary to apply an electric impulse that resonates with the bioelectric signals generated during the specific metabolic activities process that interferes. The resultant of the interference is the algebraic summation of the two waves which may be instructive and destructive, i.e. enhancement or inhibition respectively for the running process [67]. The bioelectric signals generated during metabolic activities of cells are known to be in the extremely low frequency range [67].

The difference between the percentage of inhibition in cellular division of exposed bacterial cells as measured by absorbance and viable plate counting techniques may be due to the fact that counting of microbial cells reflects real number of active micro-organism, while the absorbance technique did not differentiate between dead, inactive or active cells. As can be noticed from the TEM photos the effect of the exposures of the microorganisms to the resonance frequency QAMW in the rupture of the microbial cellular membrane which caused the release of the intercellular constituent for flow of ions to inside the cells these ions may cause some sort of chemical recombination with the DNA which results in the measured molecular alterations.

The biological cellular membrane is composed of phospholipids bilayers molecules imbedded in between protein molecules (intrinsic and extrinsic), the effect of exposures to resonance frequency QAMW may cause the disturbance of the intermolecular forces between the macromolecules forming the cellular membrane, and hence it's packing properties. All there may result in the formation of concentrated intermolecular forces that result in the formation of a phenomenon like islands which may lead to the cellular membrane rupture. Since biological cellular membranes are constructed of phospholipid bilayer macro-molecules in addition to protein molecules imbedded over and within the surface of the membrane, one may say that the highly significant increase in the electric charges are mainly due to changes in the charge distribution upon the protein molecules of the cellular membrane which can be indicators for structural changes in the cellular membrane.

It will be concluded that exposure of *S.aureus* to 0.8 Hz and *E.Coli* to 0.5 Hz QAMW caused changes in the structure properties of the protein synthesis which may affect the metabolic activity of the micro-organism and hence cell to cell communication. These analyses are supported by the antibiotic sensitivity test which is inhibitors for cell wall. This result indicates that the effect of 0.8 Hz AMW on the microbe is not only the inhibition of the cellular division of a 95% but also its activity for excreting toxins. This analysis seems logic since the exposure of the microbe in vitro caused apparent changes in the inter constituents of its cell as shown on by TEM. This results leads to a promising future of the finding vaccine for infection with *S.aureus*.

V. Conclusion

It may be concluded from the present findings that

- The new method applied in this work seems successful for the treatment of the infections with *S.aureus* and *E.Coli*.
- The advantage of this technique eliminating the side effects of treatments with antibiotics as being nondestructive, non-expensive, safe and fast, where only 120 min are needed for the exposure of the infected to stop the microbial activity and to avoid secondary harms used by prolonged treatments with antibiotics and health complications that follow treatments..
- The present findings can lead to smiling future promisis of the preparation of finding a vaccine for the infections of *S.aureus* and *E.Coli*
- It has the advantages over the running treatments of being non-invasive, fast, safe and non-expensive and can be used for the treatment of human infections, pasteurization and sterilization of food products. However, we still have some running work on the application of this technique in in vivo studies to evaluate its applicability for medical treatments of infection with *S.aureus* and *E.Coli*.

References

- [1]. C.Grassi,M.D'Ascenzo,A.Torselloetal,“Effects of 50 Hz electromagnetic fields on voltage-gated Ca²⁺ channels and their role in modulation of neuroendocrine cell proliferation and death,” *Cell Calcium*, 35(4): 307–315, 2004.
- [2]. A. Foletti, A. Lisi, M. Ledda, F. De Carlo, and S. Grimaldi,“Cellular ELF signals as a possible tool in informative medicine,” *Electromagnetic Biology and Medicine*,28(1):71–79, 2009.
- [3]. R. Goodman and M. Blank, “Magnetic field stress induces expression of hsp70,” *Cell Stress and Chaperones*,3(2):79–88, 1998.
- [4]. R. Goodman, A. Lin-Ye, M. S. Geddis et al., “Extremely low frequency electromagnetic fields activate the ERK cascade,increase hsp70 protein levels and promote regeneration in Planaria,” *International Journal of Radiation Biology*, 85(10): 851–859, 2009.
- [5]. F. Bersani, F. Marinelli, A. Ognibene et al., “Intramembrane protein distribution in cell cultures is affected by 50 Hz pulsed magnetic fields,” *Bioelectromagnetics*,18(7):463–469, 1997.
- [6]. M. de Mattei, K. Varani, F. F. Masieri et al., “Adenosine analogs and electromagnetic fields inhibit prostaglandin E2 release in bovine synovial fibroblasts,” *Osteoarthritis and Cartilage*, 17(2):252–262, 2009.
- [7]. F. Tian, T. Nakahara, K. Wake, M. Taki, and J. Miyakoshi,“Exposure to 2.45 GHz electromagnetic fields induces hsp70 at a high SAR of more than 20 W/kg but not at 5 W/kg in human glioma MO54 cells,” *International Journal of Radiation Biology*,78(5):433–440, 2002.
- [8]. M. T. Santini, A. Ferrante, R. Romano et al., “A 700 MHz 1HNMR study reveals apoptosis-like behavior in human K562erythroleukemic cells exposed to a 50 Hz sinusoidal magnetic field,” *International Journal of Radiation Biology*, 81(2): 97–113, 2005.
- [9]. A. Lisi, M. Ledda, E. Rosola et al., “Extremely low frequency electromagnetic field exposure promotes differentiation of pituitary corticotrope-derived AtT20 D16V cells,” *Bioelectromagnetics*, 27(8):641–651, 2006.
- [10]. H. Wu, K. Ren, W. Zhao, G. E. Baojian, and S. Peng, “Effect of electromagnetic fields on proliferation and differentiation of cultured mouse bone marrow mesenchymal stem cells,” *Journal of Huazhong University of Science and Technology*, 25(2):185–187, 2005.
- [11]. J.Zhou,G.Yao,J.Zhang,andZ.Chang,“CREBDNA binding activation by a 50 Hz magnetic field in HL60 cells is dependent on extra- and intracellular Ca²⁺ but not PKA,PKC, ERK, or p38 MAPK,” *Biochemical and BiophysicalResearch Communications*, 296(4):1013–1018,2002.
- [12]. R. Iorio, S. Delle Monache, F. Bennato et al., “Involvement of mitochondrial activity in mediating ELF-EMF stimulatory effect on human sperm motility,” *Bioelectromagnetics*, 32(1):15–27, 2011.
- [13]. C.Morabito,F.Rovetta,M.Bizzarri,G.Mazzoleni,G.Fano,and M. A. Mariggio, “Modulation of redox status and calcium time, single-cell approach,” *Free Radical Biology and Medicine*, 48(4): 579–589, 2010.
- [14]. K. Zwirska-Korczała, J. Jochem, M. Adamczyk-Sowa et al.,“Effect of extremely low frequency electromagnetic fields on cell proliferation, antioxidative enzyme activities and lipid peroxidation in 3T3-L1 preadipocytes-an in vitro study,”*Journal of Physiology and Pharmacology*,56(6):101–108, 2005.
- [15]. S. Di Loreto, S. Falone, V. Caracciolo et al., “Fifty hertz extremely low-frequency magnetic field exposure elicits redox and trophic response in rat-cortical neurons,” *Journal of Cellular Physiology*, 219(2):334–343, 2009.
- [16]. Y. D. Alipov, I. Y. Belyaev, and O. A. Aizenberg, “Systemic reaction of Escherichia coli cells to weak electromagnetic fields of extremely low frequency,” *Bioelectrochemistry and Bioenergetics*, 34(1):5–12, 1994.
- [17]. A. Inhan-Garip, B. Aksu, Z. Akan, D. Akakin, A. N. Ozaydin, and T. San, “Effect of extremely low frequency electromagnetic fields on growth rate and morphology of bacteria,” *International Journal of Radiation Biology*, 87(12):1155–1161, 2011.
- [18]. L. Strasak, V. Vetterl, and J. Smarda, “Effects of low-frequency magnetic fields on bacteria Escherichia coli,” *Bioelectrochemistry*, 55(1-2):161–164, 2002.
- [19]. L. Fojt, L. Strasak, V. Vetterl, and J. Smarda, “Comparison of the low-frequency magnetic field effects on bacteria Escherichia coli, Leclercia adecarboxylata and Staphylococcus aureus,” *Bioelectrochemistry*, 63(1-2): 337–41,2004.
- [20]. O. R. Justo, V. H. Perez, D. C. Alvarez, and R. M. Alegre,“Growth of Escherichia coli under extremely low-frequency electromagnetic fields,” *Applied Biochemistry and Biotechnology*, 134(2):155–163, 2006.
- [21]. E.-S. A. Gaafar, M. S. Hanafy, E. T. Tohamy, and M. H.Ibrahim, “Stimulation and control of E. coli by using an extremely low frequency magnetic field,” *Romanian Journal of Biophysics*,16(4): 283–296, 2006.
- [22]. A. Inhan-Garip, B. Aksu, Z. Akan, D. Akakin, A. N. Ozaydin, and T. San, “Effect of extremely low frequency electromagnetic fields on growth rate and morphology of bacteria,” *International Journal of Radiation Biology*, 87(12):1155–1161, 2011.
- [23]. I. V. Babushkina, V. B. Borodulin, N. A. Shmetkova et al., “The influence of alternating magnetic field on Escherichia coli bacterial cells,” *Pharmaceutical Chemistry Journal*,39(8): 398–400, 2005.
- [24]. O. R. Justo, V. H. Perez, D. C. Alvarez, and R. M. Alegre,“Growth of Escherichia coli under extremely low-frequency electromagnetic fields,” *Applied Biochemistry and Biotechnology*, 134(2): 155–163, 2006.
- [25]. L. Cellini, R. Grande, E. Di Campli et al., “Bacterial response to the exposure of 50 Hz electromagnetic fields,”*Bioelectromagnetics*,29(4): 302–311, 2008.
- [26]. I. Belyaev, “Toxicity and SOS-response to ELF magnetic fields and nalidixic acid in E. coli cells,” *Mutation Research*, 722(1): 56–61, 2011.
- [27]. Jori, G., C. Fabris, M. Soncin, S. Ferro, O. Coppellotti, D. Dei, L. Fantetti, G. Chiti, and G. Roncucci, Photodynamic therapy in the treatment of microbial infections: basic principles and perspective applications. *Lasers Surg. Med*, 38:468–481,2006.
- [28]. Maisch, T. Anti-microbial photodynamic therapy: useful in the future? *Lasers Med. Sci.* 22:83–91,2007.
- [29]. Wainwright, M. Photodynamic antimicrobial chemotherapy (PACT). *J. Antimicrob. Chemother.* 42:13–28, 1998.
- [30]. Mourad, P. D., F. A. Roberts, and C. McInnes. Synergistic use of ultrasound and sonic motion for removal of dental plaque bacteria. *Compend.Contin. Educ. Dent.* 28:354–358, 2007.
- [31]. Carmen, J. C., B. L. Roeder, J. L. Nelson, B. L. Beckstead, C. M. Runyan, G. B. Schaalje, R. A. Robison, and W. G. Pitt. Ultrasonically enhanced vancomycin activity against Staphylococcus epidermidis biofilms in vivo. *J. Biomater. Appl.* 18:237–245, 2004.
- [32]. Ensing, G. T., B. L. Roeder, J. L. Nelson, J. R. van Horn, H. C. van der Mei, H. J. Busscher, and W. G. Pitt. Effect of pulsed ultrasound in combination with gentamicin on bacterial viability in biofilms on bone cements in vivo. *J. Appl. Microbiol.* 99:443–448, 2005.
- [33]. Pitt, W. G., M. O. McBride, J. K. Lunceford, R. J. Roper, and R. D. Sagers. Ultrasonic enhancement of antibiotic action on gram-negative bacteria. *Antimicrob. Agents Chemother.* 38:2577–2582, 1994.
- [34]. Rediske, A. M., N. Rapoport, and W. G. Pitt. Reducing bacterial resistance to antibiotics with ultrasound. *Lett. Appl. Microbiol.* 28:81–84, 1999.

- [34]. Leung E, Weil DE, Raviglione M, Nakatani H; World Health Organization World Health Day Antimicrobial Resistance Technical Working Group (2011) The WHO policy package to combat antimicrobial resistance. Bull World Health Organ 89: 390-392.
- [35]. Infectious Diseases Society of America (IDSA), Spellberg B, Blaser M, Guidos RJ, Boucher HW, et al. (2011) Combating antimicrobial resistance: policy recommendations to save lives. Clin Infect Dis 52 Suppl 5: S397-428.
- [36]. Liang, Z., Cheng, Z. and Mittal, G. (2006) Inactivation of spoilage microorganisms in apple cider using a continuous flow pulsed electric field system. Food Sci Technol-LEB 39,350–356.
- [37]. Jaegu, C., Douyan, W., Takao, N., Sunao, K., Hidenori, A., Xiaofei, L., Hiroshi, S., Harumichi, S. et al. (2008) Inactivation of spores using pulsed electric field in a pressurized flow system. J Appl Phys 104, 701–706.
- [38]. Fox, M., Esveld, D., Mastwijk, H. and Boom, R. (2008) Inactivation of *L. plantarum* in a PEF microreactor: the effect of pulse width and temperature on the inactivation. Innov Food Sci Emerg Technol 9, 101–108.
- [39]. Ruiz-Gomez, M., Sendra-Portero, F. and Martinez-Morillo, M. (2010) Effect of 2.45 mT sinusoidal 50 Hz magnetic field on *Saccharomyces cerevisiae* strains deficient in DNA strand breaks repair. Int J Radiat Biol 86, 602–611.
- [40]. Ayse, I., Burak, A., Zafer, A., Dilek, A., Nilufer, A. and Tangu, S. (2011) Effect of extremely low frequency electromagnetic fields on growth rate and morphology of bacteria. Int J Radiat Biol 87, 1155–1161.
- [41]. Fadel, M.A., Reem, H., Amany, A. and Fakhry, F. (2005) Control of Ehrlich tumor growth in mice by electromagnetic wave at resonance frequency, in vivo. Electromagn Biol Med 24, 9–12.
- [42]. Fadel, M.A., El-Gebaly, R., Aly, A., Sallam, A., Sarhan, O. and Eltohamy, H. (2010) Preventing of Ehrlich tumor metastasis in liver, kidney and spleen by electromagnetic field. Int J Phys Sci 5, 2057–2065.
- [43]. Fadel, M.A., Ahmed, M.A. and El Hag, M.A. (2009) Control of *Sclerotium cepivorum* (Allium White Rot) activities by electromagnetic waves at resonance frequency. Aust J Basic Appl Sci 3, 1994–2000.
- [44]. Rosenberg, B., L. Vancamp, and T. Krigas. Inhibition of cell division in *Escherichia coli* by electrolysis products from a platinum electrode. Nature 205:698–699, 1965.
- [45]. Rosenberg, B., L. VanCamp, J. E. Trosko, and V. H. Mansour. Platinum compounds: a new class of potent antitumor agents. Nature 222:385–386, 1969.
- [46]. Blenkinsopp, S. A., A. E. Khoury, and J. W. Costerton. 1992. Electrical enhancement of biocide efficacy against *Pseudomonas aeruginosa* biofilms. Appl. Environ. Microbiol. 58:3770–3773, 1992.
- [47]. Costerton, J. W., B. Ellis, K. Lam, F. Johnson, and A. E. Khoury. Mechanism of electrical enhancement of efficacy of antibiotics in killing biofilm bacteria. Antimicrob. Agents Chemother. 38:2803–2809, 1994.
- [48]. Rabinovitch, C., and P. S. Stewart. Removal and inactivation of *Staphylococcus epidermidis* biofilms by electrolysis. Appl. Environ. Microbiol. 72:6364–6366, 2006.
- [49]. van der Borden, A. J., P. G. Maathuis, E. Engels, G. Rakhorst, H. C. van der Mei, H. J. Busscher, and P. K. Sharma. 2007. Prevention of pin tract infection in external stainless steel fixator frames using electric current in a goat model. Biomaterials 28:2122–2126.
- [50]. van der Borden, A. J., H. van der Werf, H. C. van der Mei, and H. J. Busscher. 2004. Electric current-induced detachment of *Staphylococcus epidermidis* biofilms from surgical stainless steel. Appl. Environ. Microbiol. 70:6871–6874.
- [51]. Caubet, R., F. Pedarros-Caubet, M. Chu, E. Freye, M. de Belem Rodrigues, J. M. Moreau, and W. J. Ellison. A radio frequency electric current enhances antibiotic efficacy against bacterial biofilms. Antimicrob. Agents Chemother. 48:4662–4664, 2004.
- [52]. Pareilleux, A., and N. Sicard. Lethal effects of electric current on *Escherichia coli*. Appl. Microbiol. 19:421–424, 1970.
- [53]. R. Iorio, S. Delle Monache, F. Bennato et al., “Involvement of mitochondrial activity in mediating ELF-EMF stimulatory effect on human sperm motility,” Bioelectromagnetics, 32(1):15–27, 2011.
- [54]. Saravanan M. Biosynthesis and in-vitro studies of silver Bio-nanoparticles Synthesized from *Aspergillus* species and its Antimicrobial Activity against Multi Drug Resistant clinical isolates, World Academy of Science Engineering and Technology, 68:728-731, 2010.
- [55]. Obermeier A, Matl FD, Friess W, and Stemberger A (2009). Growth inhibition of *Staphylococcus aureus* induced by low-frequency electric and electromagnetic fields. Int J Bioelectromagnetics. 30(4):270-279, 2009.
- [56]. Atlas R. Principles of Microbiology. Mosby-Year book, INC, 1995.
- [57]. Demicheli M, Goes A, Ribeiro A. Ultrastructural changes in *Paracoccidioides brasiliensis* yeast cells attenuated by gamma irradiation. J Compil, 50: 397–402, 2007.
- [58]. Kim, S.H, Hyeong-Seon, L, Deok-Seon, R, Soo-Jae Choi, and Dong-Seok L, Antibacterial Activity of Silver-nanoparticles Against *Staphylococcus aureus* and *Escherichia coli* Korean., J. Microbiol. Biotechnol., 39 (1): 77–85, 2011.
- [59]. Ansari MA, Khan HM, Khan AA, Malik A, Sultan A, Shahid M, Shujatullah F, Azam, A Evaluation of antibacterial activity of silver nanoparticles against MSSA and MRSA on isolates from skin infections., Biology and Medicine, 3 (2):141-146, 2011.
- [60]. Rachel, C. A, Richard G. Haverkamp, Pak-Lam Y, Investigation of morphological changes to *Staphylococcus aureus* induced by ovine-derived antimicrobial peptides using TEM and AFM FEMS., Microbiology Letters, 240:105–110, 2004.
- [61]. Lok CN, Ho CM, Chen R, He QY, Yu WY, Sun H, et al. Proteomic analysis of the mode of antibacterial action of silver nanoparticles., J of Proteomic Research., 5:916-924, 2006.
- [62]. Sahar E.A, Hussein A. M, Marzoga F.R, Effects of electric field on histopathological study, electrical properties and enzymes function of liver of albino rats., Research Inventy: International Journal Of Engineering And Science., 4(12):25-37, 2014.
- [63]. Santhana R L, Hing HL, Baharudin O, Teh Hamidah Z, Aida SR, Nor Asih CP, Vimala B, Paramsarvaran S, Sumarni G, Hanjeet K. Rapid Method For Transmission Electron Microscope Study of *Staphylococcus aureus* ATCC 25923. J. Annals of Microscopy, 7:102-108, 2007.
- [64]. Denyer, S. P. Mechanisms of action of biocides. International Biodeterioration. 26, 89-100, 1990.
- [65]. Diaz-Visurraga J, Garcia A, Cardenas G. Lethal effect of chitosan-Ag (I) films on *Staphylococcus aureus* as evaluated by electron microscopy. Journal of Applied Microbiology. 108:633-646, 2010.
- [66]. Fadel MA (1998). A new metabolic biomagnetic resonance model to describe the interaction of ELF EM fields with biological systems. International School on Theoretical Biophysics, Moscow May
- [67]. Fadel MA, Azza MG, Massarat BS, Ashraf MA, Amira HE. Control of *Salmonella* activity in rats by pulsed ELF Magnetic field (in vivo study). Int. J. Dental. Med Res. 5(2):129-135, 2012.