

Study of Wire Cut Electric Discharge Machining Process Using Taguchi's Design

¹V.Mastan, ²N.B.Jyothi, ³P.M.Naresh Kumar

¹(Assistant Professor, Mechanical Engineering Department, CM? Engineering College, Hyderabad.)

²(Assistant Professor, Mechanical Engineering Department, CM? Engineering College, Hyderabad.)

³(Asst.Professor,Mechanical Engineering Department, CMR Engineering College, Hyderabad)

Abstract: This research outlines the Taguchi's Parameters Design Approach which is applied to optimize machining parameters of dimensional accuracy in wire cut electric discharge machining (WEDM). Analysis of variance (ANOVA) is used to study the effect of process parameters on machining process. This procedure eliminates the need for repeated experiments, save time and conserves the material as opposed by the conventional procedure. The machining parameters investigated are pulse on time(Ton) , pulse off time (Toff),Spark gap voltage(SV) and gap current(IP). A series of experiments are conducted using EDM to related the machining parameters and dimensional accuracy. An orthogonal array has been used to conduct the experiments and raw data and signal to noise ratio are employed to analyse the influence of these parameters on dimensional accuracy. The methodology could be useful in predicting dimensional accuracy parameters as a function of machining parameters and specimen parameters. The main objective is to find out the important factors and combination of factors influencing the machining process to achieve the best material removal rate (MRR). It has been observed that effect of combination of factor for each parameter measure is difficult. In this study MINITAB 15 is used to: find out the effect of each parameter on response characteristic and to predict the optimum setting of control parameters. In this study EN24 Steel is used for the experimental work as work piece.

Keywords: Wire electrical discharge machining , EN 24 , Minitab 15 Software , Taguchi Method .

I. Taguchi Loss Function

The heart of Taguchi Method is the definition of the nebulous and elusive term „Quality“ as the characteristic that avoids loss to the society form the time the product is shipped. Loss is measured in terms of monetary units and is related to quantifiable product characteristics. Taguchi defines quality loss via „Loss function“ He unites financial loss with the functional characteristics specifying through a quadratic relationship that comes from a Taylor series expansion. The quadratic takes the form of a parabola. Taguchi defines the loss function as a quantity proportional to the square of deviation from the nominal quality characteristics. The representation of the Taguchi loss function is graphically shown in fig. 1. He found the following quadratic

from to be practical workable function.

$$L(y) = K (y-m)^2 \text{ ----- (1)}$$

Where,

L = loss in monetary unit, y = actual value of the characteristic.

m = value at which the characteristic should be set (target value).

K= constant depending on the magnitude of the characteristic and monetary unit involved

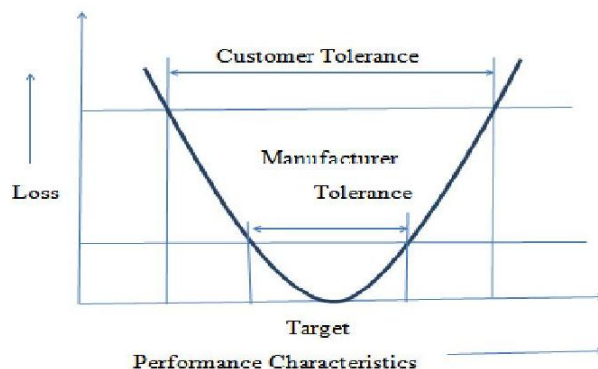

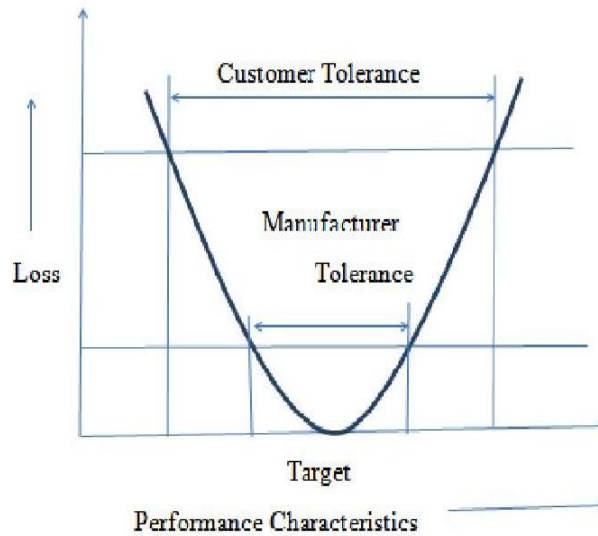

Fig1: Taguchi loss function

The characteristics of the loss function are

1. The more the product characteristic deviates from the target value, greater is the loss. The loss must be zero when the quality characteristic of a product meets its target value.
2. The loss is continuous function and not a sudden step as in the case of traditional approach. The consequence of the continuous function illustrates the point that merely making a product within the specification limits does not necessarily mean that product is of good quality.

II. Higher The Better (Hb)

Performance characteristics, whose values are preferred when high, are calculated using this approach. Such factors are tool life, material removal rate, etc.

The following equation is used to calculate the S/N ratio for HB type of characteristics:

$$(S/N)_{HB} = -10 \text{ Log} \frac{1}{R} \frac{1}{\sum_{j=1}^j y_j^2} \text{----- (3)}$$

Where

y_j = Value of characteristic in an observation
 R = number of repetitions in a trial.

Linear graphs (Three-level OAs)

An L27 OA linear graph is shown in Fig 2. The dots represent columns available for a three-level factor, which is allocated 2 degree of freedom. The line represents the two columns, which together evaluate the interaction of the dot columns. The interaction will require 4 degree of freedom; hence two columns are necessary to assign the interaction.

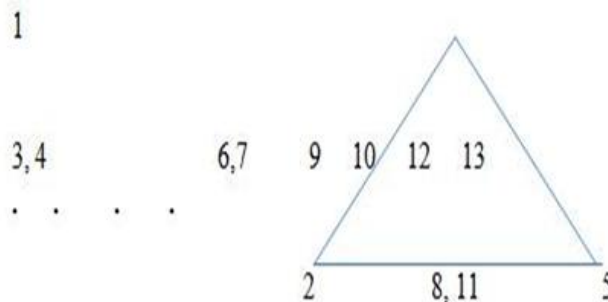

Fig 2: OA Linear Graph

Wire electrical discharge machining (WEDM)

Wire electrical discharge machining (WEDM) (Fig 3) is a widely accepted non-traditional material removal process used to manufacture components with intricate shapes and profiles. It is considered as a unique adaptation of the conventional EDM process, which uses an electrode to initialize the sparking process. However, WEDM utilizes a continuously traveling wire electrode made of thin copper, brass or tungsten of diameter 0.05-0.3 mm, which is capable of achieving very small corner radii. The wire is kept in tension using a mechanical tensioning device reducing the tendency of producing inaccurate parts. During the WEDM process, the material is eroded ahead of the wire and there is no direct contact between the work piece and the wire, eliminating the mechanical stresses during machining.

In addition, the WEDM process is able to machine exotic and high strength and temperature resistive (HSTR) materials and eliminate the geometrical changes occurring in the machining of heat-treated steels.

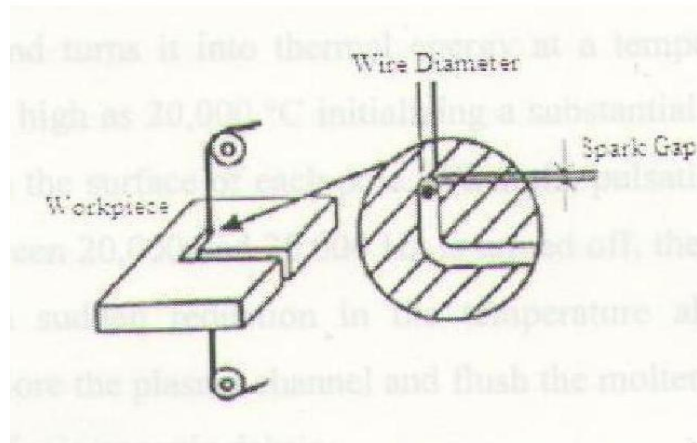

Fig 3. Principle of WEDM

WEDM was first introduced to be manufacturing industry in the late 1960s. The development of the process was the result of seeking a technique to replace the machined electrode used in EDM. In 1974, D.H. Dulebohn applied the optical-line follower system to automatically control the shape of the component to be machined by the WEDM process. By 1975 its popularity was rapidly increasing, as the process and its capabilities were better understood by the industry. It was only towards the end of 1970s, when computer numerical control (CNC) system was initiated into WEDM that brought about a major evaluation of the machining process. As a result, the broad capabilities of the WEDM process were extensively

Exploited for any through hole machining owing to the wire, which has to pass through the part to be machined. The common application of WEDM include the fabrication of stamping and extrusion tools and dies, fixtures and gauges, prototypes, aircraft and medical parts, and Grinding wheels form tools.

Wire electrical discharge machining Process

The material removal mechanism of WEDM is very similar to the conventional EDM Process involving the erosion effect of produced by the electrical discharge (sparks). In WEDM, material is eroded from the work piece by a series of discrete sparks occurring between the work piece and the wire separated by a stream of dielectric fluid, which is continuously fed to the machining zone. However, today's WEDM process is commonly conducted on the work piece that are totally submerged in a tank filled with dielectric fluid. Such a submerged method of WEDM promotes temperature stabilization and efficient flushing especially in cases where the work piece has varying thickness. The WEDM process make use of electrical energy generating a channel of plasma between the cathode and anode, and turns into thermal energy at a temperature in the range between of 8000-12000°C or as high as 20,000°C initializing a substantial amount of heating and melting of material on the surface of each pole. When the pulsating direct current power supply occurring between 20,000 and 30,000 Hz is turned off, the plasma channel breaks down. This causes a sudden reduction in the temperature allowing the circulating dielectric fluid to implore the plasma channel and push the molten particle from the pole surface in the form of microscopic debris (Fig 4).

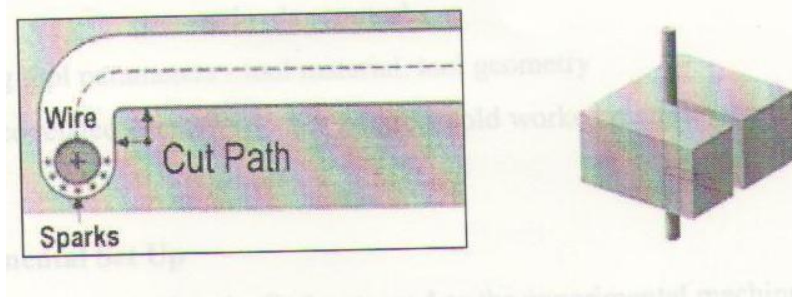

Fig 4 Process of Wire- EDM

III. Factors Affecting MRR

The factors affecting quality characteristics of machined parts are given below: Machining parameters – Gap Voltage, Discharge Current, Pulse duration, Gap control and pulse control. Machining tool parameters – Tool material, Tool geometry Work piece related parameters – hot worked, cold worked materials, hardness.

IV. Experimental Set Up

A Wire EDM machine (Omni-Cut) was used as the experimental machine in this study. A pure brass wire with a diameter 0.25mm was used as an electrode to erode a work piece of special tool steel, EN 24, (flat plate). The gap between work piece and the wire was flooded with a moving dielectric fluid (distilled water). Machining Experiments for determining the performance of WEDM machining for enhancing the MRR were carried out by using distilled water as a dielectric fluid. Gap Voltage in the range of 30 to 90 Volts; Ton in the range of 105 to 125 (01 to 09 microseconds);

T off in the range of 40 to 60 (02 to 10 microseconds and gap current in the range of 120 to 200 amps. To perform the experimental design, three levels of each machining parameters (Ton, Toff, Gap Voltage and Gap Current) Were selected as shown in table 3.1. An L27 orthogonal array is used to specify the experiments. To take in to account the effect of noise factors and to study the non linear relationship among the process variables, five values of cutting speeds were taken at each work piece of area 5x5 mm²(Table1)

Table 1. Process parameters and their ranges

Factors	Parameters	Symbols	Levels		
			L 1	L 2	L 3
A	Pulse on Time	Ton	105	115	125
B	Pulse off Time	T off	40	50	60
C	Spark Gap Set Voltage	SV	30	60	90
D	Peak Current	IP	120	160	200

Main parts of WEDM and their specifications are given below:

Machine

Tool Height : 6 Ft
 Width : 5 Ft
 Net Weight : 300 Kgs

WORK HEAD

Travel of Quill : 200 mm

Maximum load lifting capacity including

Accessories : 10 Kgs

WORK TANK

Length : 600 mm
 Width : 370 mm
 Height : 200 mm

OPERATIONAL DATA

1) Wire

Material : Brass
 Diameter : 0.25 mm

2) Work piece

Material : EN 24 Tool steel

Size : 168 x 168 x 39.2 mm³.

EN 24 is a high quality, high tensile, shock resistance, good ductility and resistance to wear alloy steel, usually available in from stocks in round bar and plates(Table 2). This steel is made through hardening at 823/850°C until heated through. Quench in oil, Then tempering by heating uniformly and thoroughly at selected temperature, up to 660°C and hold at this temperature for two hrs per inch of total thickness, after that stress relieving by heating slowly up to 650-670°C and cooling EN24 tool steel in a furnace or in air .

Table 2. Typical analysis of EN 24 tool steel

Constituents	C	Si	Mn	Ni	Cr	Mo
%	0.40	0.30	0.60	1.50	1.20	0.25

3) DIELECTRIC FLUID : Distilled.

Experimental data of MRR

Table shows experimental data of MRR obtained using above discussed procedure section. Data of each experiment is obtained by taking mean of five values of cutting speed. S/N data of the MRR are also given in table 3.2 The signal to noise ratio (S/N) ratio of the individual runs, which is calculated as:

$$S/N = -10 \log_{10} \left[\frac{R}{j} \sum_{j=1}^j (y_j - \bar{y})^2 \right]$$

Where y_i is the individual cutting speed in a run. The S/N ratio is a statistic

which indicates the values and dispersion of the response variable with the given noise factor. In this case , the S/N ratio equation is based on the Taguchi higher-the-best loss function, as the idea is to minimise the response. The data in the table 3.2 can be analysed using informal and statistical methods. This begins with determining the effect of each treatment level on the response and S/N ratio. .

V. Data Analysis And Discussion

The following section includes the basics steps followed for analysis through Taguchi Method, for the results obtained from the experiments discussed in the previous chapter.

Analysis of Material Removal Rate Values

An ANOVA was run using the whole model analysis feature, in order to look at the combined effect of the parameters.

Table 3. Analysis of variance for S/N ratio

Source	DF	Seq. SS	Adj. SS	Adj. MS	F	P
A	2	871.65	871.654	435.827	133.09	0.000
B	2	219.53	219.533	109.767	33.52	0.001
C	2	677.22	677.220	338.610	103.40	0.000
D	2	6.08	6.076	3.038	0.93	0.446
A*B	4	1.70	1.702	0.426	0.13	0.966
A*C	4	2.52	2.524	0.631	0.19	0.934
A*D	4	8.63	8.634	2.158	0.66	0.642
Residual Error	6	19.65	19.649	3.275		
Total	26	1806.99				

Table 4. Analysis of variance for mean

Source	DF	Seq. SS	Adj. SS	Adj. MS	F	P
A	2	1.24171	1.24173	0.62087	15.48	0.004
B	2	0.64394	0.64394	0.32197	8.03	0.020
C	2	1.06886	1.06886	0.53443	13.32	0.006

D	2	0.08428	0.08428	0.04214	1.05	0.406
A*B	4	0.20934	0.20934	0.05233	1.30	0.366
A*C	4	0.31122	0.31122	0.07781	1.94	0.223
A*D	4	0.15538	0.15538	0.03885	0.97	0.489

Response table for signal to noise ratios Larger is better

Level	A	B	C	D
1	-19.164	-7.780	-6.308	-12.134
2	-10.383	-12.347	-10.309	-11.825
3	-5.422	-14.751	-18.351	-11.009
Delta	13.742	6.881	12.044	1.125
Rank	1	3	2	4

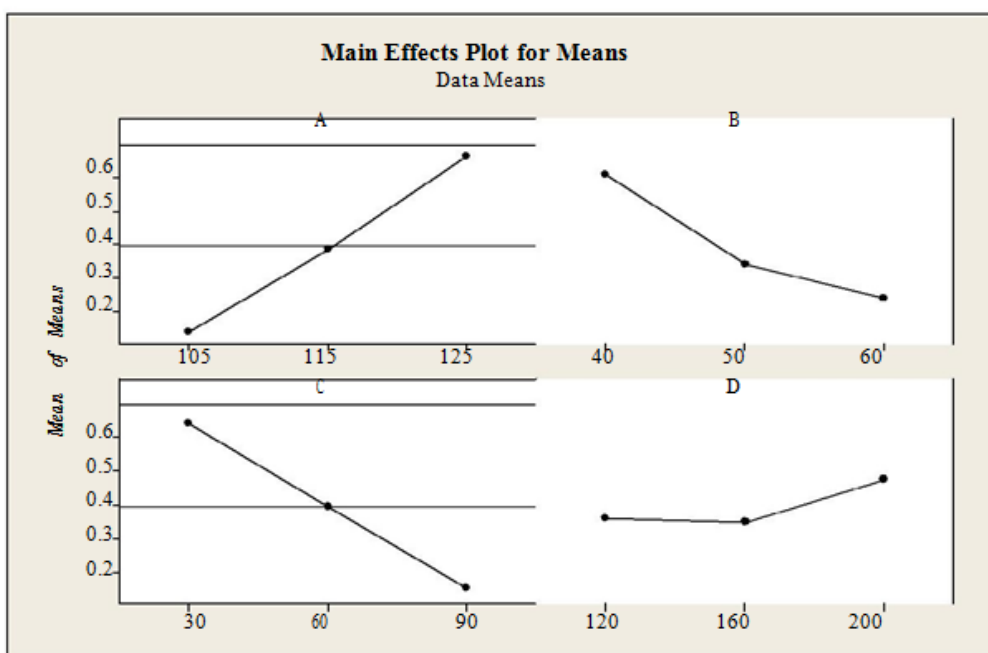
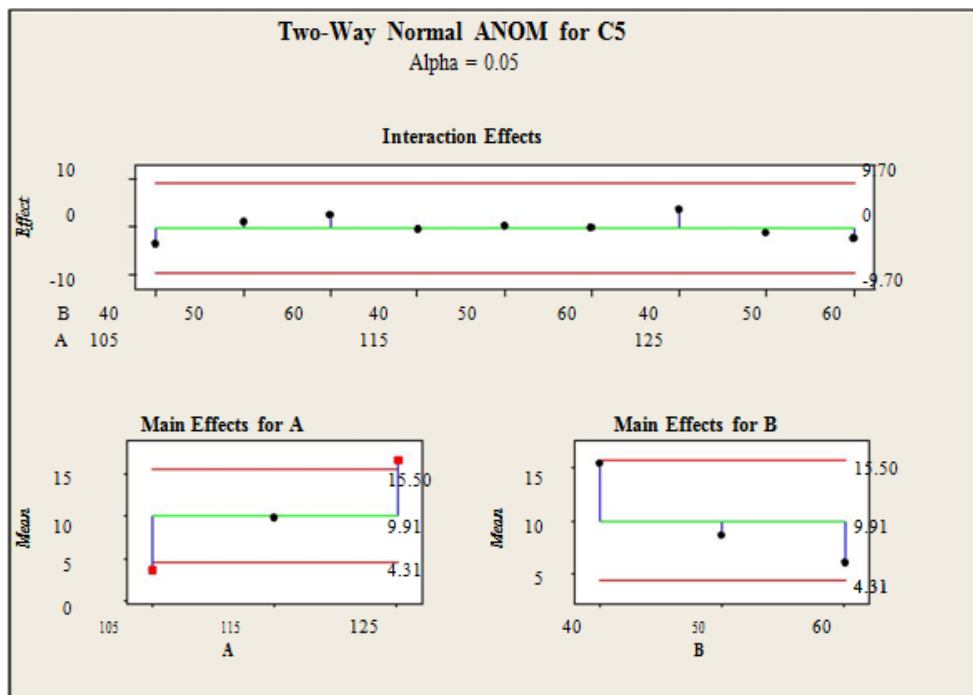

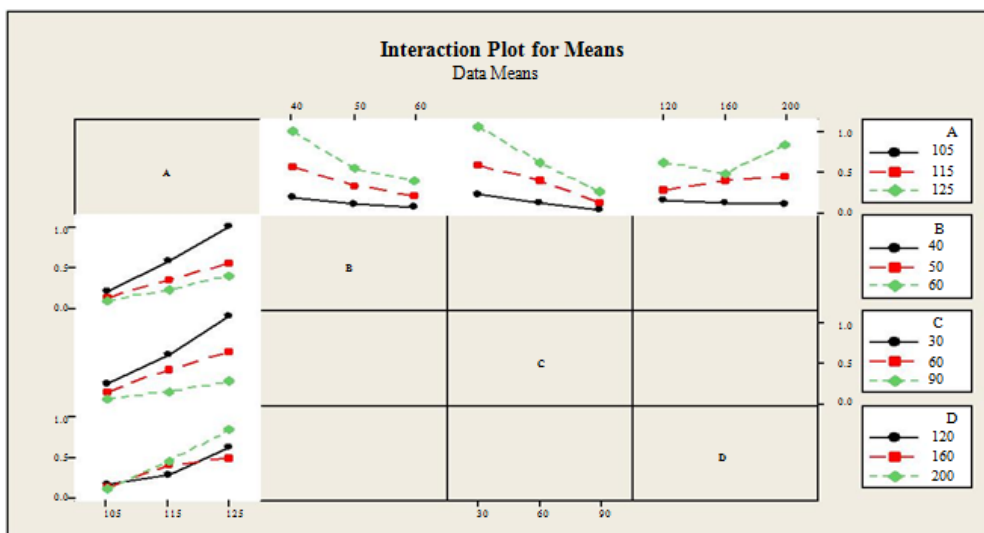
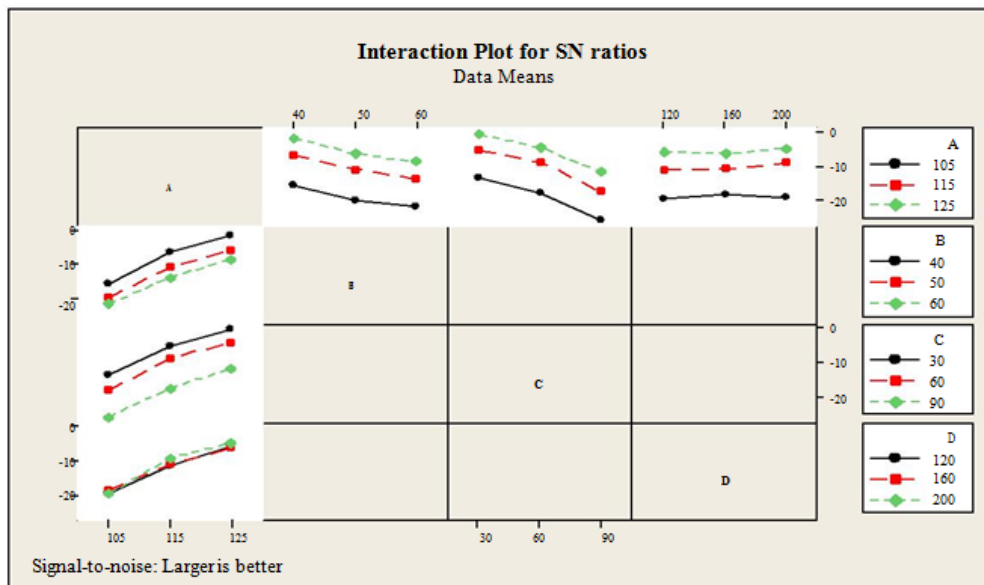
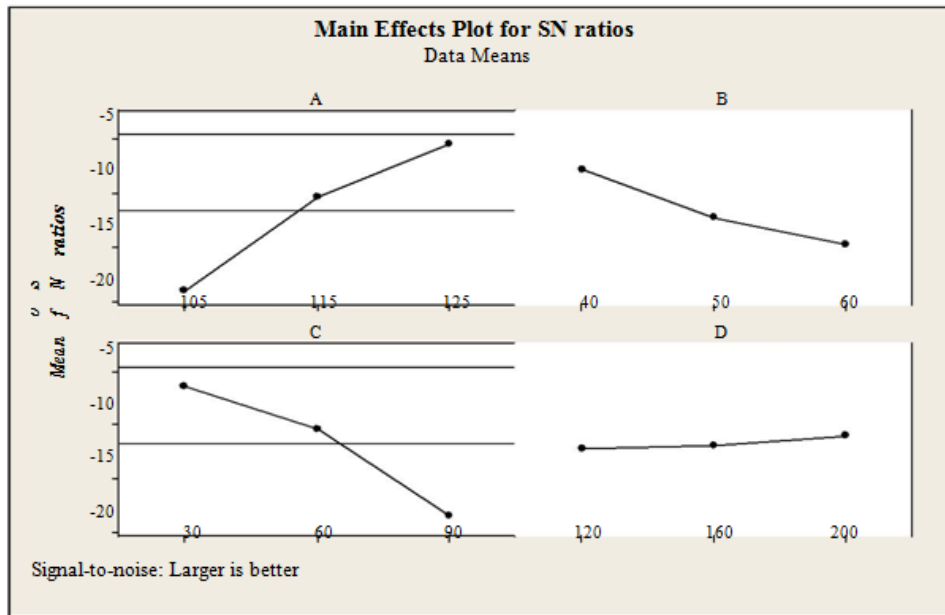

It is revealed from the main effects plot for SN ratio and means that the optimal setting of the parameters for optimizing MRR is third level of Ton, first level of Toff and first level of SV are significant parameters of the experiment.

Estimation of optimal value of the MRR

After analysing S/N response graph and response graph for the mean data, (fig 2 and 3) the optimal machining condition for the selected quality characteristic i.e. MRR is:

T on (A, Level 3) : 125
 T off (B, Level 1) : 40
 SV, Gap Voltage (C, Level 1): 30 Volts

$$\mu\text{MRR} = \text{Predicted optimal value of MRR} = A_3 + B_1 + C_1 - 2T = 16.599 + 15.152 + 16.015 - 2 \times 9.89 = 27.986 \text{ mm}^3/\text{min}$$

The confidence interval is a maximum and minimum value between which the true average should fall at some stated percentage of confidence.

From table 2

$f_e = 6$, $V_e = 25.07$, At 95% stated confidence level

$F_{\alpha; (1, f_e)}$ = The F-ratio at a confidence level of $(1 - \alpha)$ against DOF of 1 (mean value) and error

DOF : $F_{.05(1,6)} = 5.99$ (Tabulated F-ratio)

$$\eta = N / 1 + [\text{Total DOF associated with terms used in } \mu \text{ estimate}]$$

$$\eta = 135 / 1 + 6 = 135 / 7 = 19.28$$

The expression for computing CICE (Confidence interval for a sample group) for confirmation experiments is as follows:

$$\text{CICE} = \sqrt{F_{\alpha; (1, f_e)} V_e} [1/\eta + 1/R]$$

R = sample size for confirmation experiment = 3

$$\text{CICE} = \sqrt{5.99 \times 25.07} [1/19.28 + 1/3], \text{ CICE} = 7.60$$

The predicted optimal range of MRR for a sample group is

$$(\mu\text{MRR} - \text{CICE}) < \mu\text{MRR} < (\mu\text{MRR} + \text{CICE}), 20.38 < \mu\text{MRR} < 35.58, \text{ Where } \mu\text{MRR} = 27.986$$

The expression for computing CIPOP (Confidence interval for entire population) for confirmation experiments is as follows:

$$\text{CIPOP} = \sqrt{F_{\alpha; (1, f_e)} V_e} / \eta = \sqrt{5.99 \times 25.07} / 19.28 = 2.79$$

The predicted optimal range for the entire population of MRR is: $(\mu\text{MRR} - \text{CIPOP}) < \mu\text{MRR} < (\mu\text{MRR} + \text{CIPOP})$ 25.19 < μMRR < 30.77

The average response to three repetition of this trial is 28.25. The predicted range of the optimal MRR i.e. 25.19 < μMRR < 30.77, is thus satisfied.

Confirmation Experiment

Three confirmation experiments were carried out at the predicted settings of the process variables i.e.

Ton (A, Level 3) : 125
 T off (B, Level 1) : 40
 SV, Gap Voltage (C, Level 1): 30 Volts

The average value of the three experiments is 28.25 mm³/min, This value clearly lies between predicted optimal range of the response at 95% confidence level.

25.19 < μMRR < 30.77 Hence the selected optimal values of the machining parameter for MRR are established/implemented.

VI. Conclusion And Future Work

Conclusion

- 1) The optimal setting of parameters for maximizing the MRR is: Ton – 125, T off – 40, and SV -30 Volts
- 2) The following are the percentage contributions of the significant parameters to the variation of MRR in machining of Tool steel part using Brass wire electrode.

FOR MEAN DATA

Ton	: 31.393 %
T off	: 16.279 %
SV	: 27.022 %

FOR S/N DATA

Ton	: 48.24 %
T off	: 12.15 %
SV	: 37.48 %

The percentage contribution of parameters reveals that the influence of the Ton and voltage in controlling mean and variance of MRR is larger than that of T off. The predicted optimal range of MRR is:

25.19 < μ MRR>

30.77 CICE = 7.60

CIPOP = 2.79

Future Scope for Work

The Taguchi methodology is best suited to optimize quality characteristics individually and hence can be well applied to other responses of machining process e.g. surface roughness, tool wear, power consumption etc. For multi response optimization, Taguchi technique may be used in conjunction with either Utility Concept or Grey Relationship Grade analysis.

References

- [1] Seiji Kumagai, Naoki Sato and Koichi Takeda, "Operation parameter optimization for fabrication of narrow, deep hole in metal by electrical discharge machining using a dielectric-encased wire-electrode," *Journal of Material Processing Technology*, Volume 189, Issue 1-3, 6 July 2007, Pages 310-315.
- [2] SS Mahapatra, A Patnaik, "Parametric optimization of wire electrical discharge machining process using Taguchi Method," *Journal of Brazilian Society of Mechanical Science & Engineering*, Volume 28, Oct./Dec. 2006.
- [3] Ting-Cheng Chang, Feng-Che Tsai, Jiuan-Hung Ke, "Data mining and Taguchi method combination applied to the selection of discharge factors and the best interactive factor combination under multiple quality properties," *The International Journal of Advance Manufacturing Technology*, Volume 31, Numbers 1-2, November 2006, Pages 164-174.
- [4] Y. H. Guu and Max Ti-Kuang Hou, "Effect of machining parameters on surface textures in EDM of Fe-Mn-Al alloy," *Materials Science and Engineering*, Volume 466, *Mechanical Science & Engineering*, Volume 466, issues 1-2, 25 September 2007, Pages 61-67.
- [5] Q. H. Zhang, R. Du, J. H. Zhang, and Q. B. Zhang, "An Investigation of ultrasonic assisted electric discharge machining in gas," *International Journal of Machine Tools and Manufacture*, Volume 46, Issue 12-13, October 2006, Pages 1582-1588.
- [6] Y. S. Liao, J. T. Huang, Y. H. Chen, "A study to achieve a fine surface finish in Wire -EDM," *Journal of Material Processing Technology*, Volume 149, Issue 1-3, 10 June 2004, Pages 165-171.
- [7] R. E. Williams and K. P. Rajurkar, "Study of wire electric discharge machined surface characteristics," *Journal of Material Processing Technology*, Volume 28, number 1-2, September 1991, pages 127-138.
- [8] D. T. Pham, S. S. Dimov, "Micro-EDM recent development and research issues," *Journal of Material Processing Technology*, Volume 149, Issues 1-3, 10 June 2004, Pages 50-57

Bibliography

- [1] Ross, Phillip J., *Taguchi Technique for Quality Engineering*, McGraw Hill Book Company, New York, 1996.
- [2] Jain R. K., *Production Technology*, Khanna Publication, New Delhi
- [3] HMT Bangalore, *Production Technology*, TMH Publishing company Limited, New Delhi.
- [4] William & William, *Manufacturing Process for Technology*, Prentice hall New Jersey.
- [5] Pandey P.C. & Shah H.S., *Modern Machining Process*, TMH Publishing Company Limited, New Delhi. Ghosh Amitabha & Malik Ashok Kr., *Manufacturing Process*, East West Press Private Limited, New Delhi, 1995.